

C/D Turnier Balingen

Datum	Prüfung	LK	Pattern
D Turnier:			
19.10.2024	Greenhorse Basis	Jungpferde Pattern 4- jährig	# 5
19.10.2024	Greenhorse Ranch Riding	Jungpferde Pattern 4- jährig	# 5
19.10.2024	Greenhorse Reining	Jungpferde Pattern 4- jährig	# 1
19.10.2024	Western Riding	1 – 3 A/B	# 7
19.10.2024	Reining	4 A/B	# 15
C Turnier:			
20.10.2024	Reining	1-3 A/B	# 8
20.10.2024	Reining	4 A/B	# 14



 BESTICKUNG

 TEAMBEKLEIDUNG

WWW.CIBLU.EU

CIBLU Stich  info@ciblu-stich.eu

D Turnier Samstag, 19.10.

SSH

LK 4/5 A/B

Showmanship at Halter

LK 4/5 A/B #3

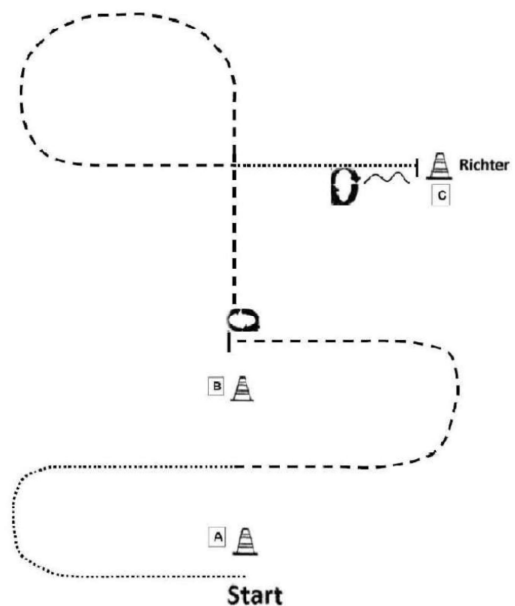

Aufstellung bei A

1. Walk serpentine.
2. Trot serpentine.
3. Stop, turn 90° right.
4. Trot.
5. Walk straight line, stop.
6. Set up for inspection.
7. Back straight line.
8. Turn 90° right.

Walk and leave the arena.

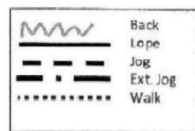

© Constance Waber, 2019

LK 4/5 A/B WHS

WT = ohne Lope

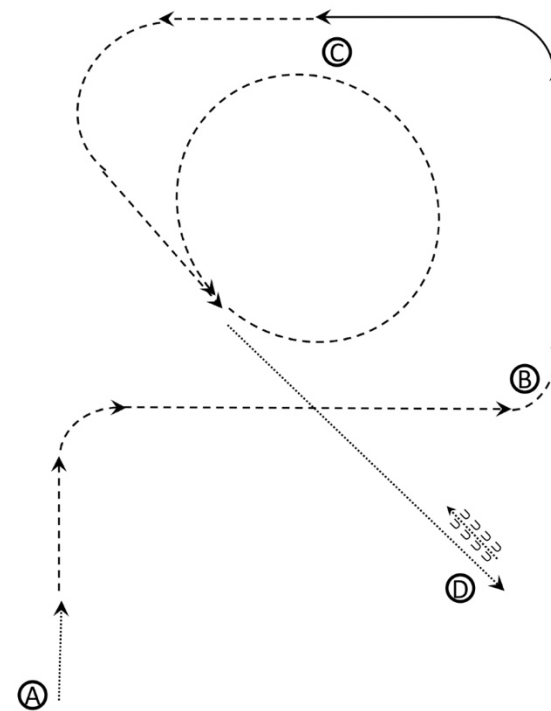

1. Aus dem Stand zwei Pferdelängen Schritt
2. Trab von A nach B
3. Lope ab B wie eingezeichnet,
4. Trab auf der Höhe von C, Trabzirkel
5. Im Schritt zu D
6. Zwei Pferdelängen rückwärts
Verlasse die Arena im Schritt

Turnier – Samstag, 19.10.2024
LK 1-3 A/B WHS

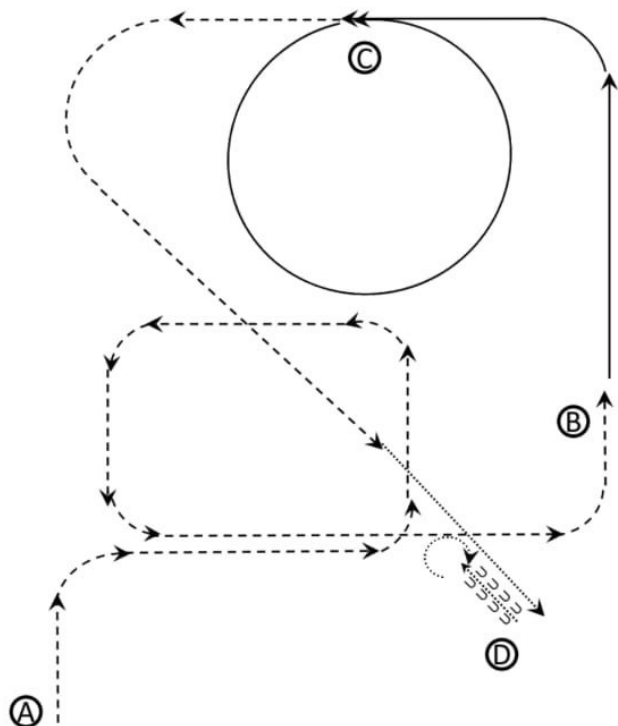

1. Aus dem Stand in den Trab von A um B herum
2. Linksgalopp bei B
3. Bei C Linksgaloppzirkel
4. Bei C Jog
5. Zwei Pferdelängen Schritt
6. Stopp bei D
7. Eine Pferdelänge rückwärts
8. Hinterhandwendung 360° egal in welche Richtung
Verlasse die Arena im Schritt

Walk→
 Jog - - - - -→
 Ext. Jog - · - · - →
 Lope - - - - -→
 Ext. Lope ———→

SAVE THE DATE

★ AMERICANA®



3.-7. September 2025
MESSE FRIEDRICHSHAFEN

GREAT HORSES ★ GREAT RIDERS ★ GREAT FUN



www.americana.de

Diana Bürgel – Literarische Übersetzerin

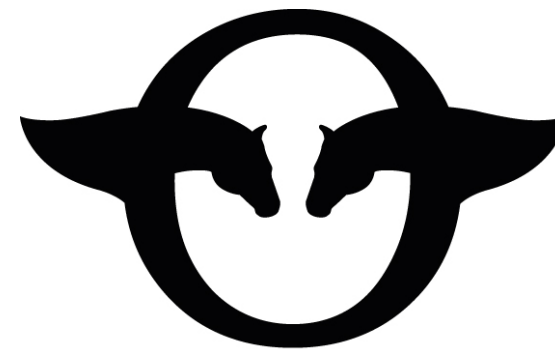

OBERMÜLLER
PERFORMANCE HORSES

LK 4/5 A/B
Walk - Trot Trail ohne Lope!

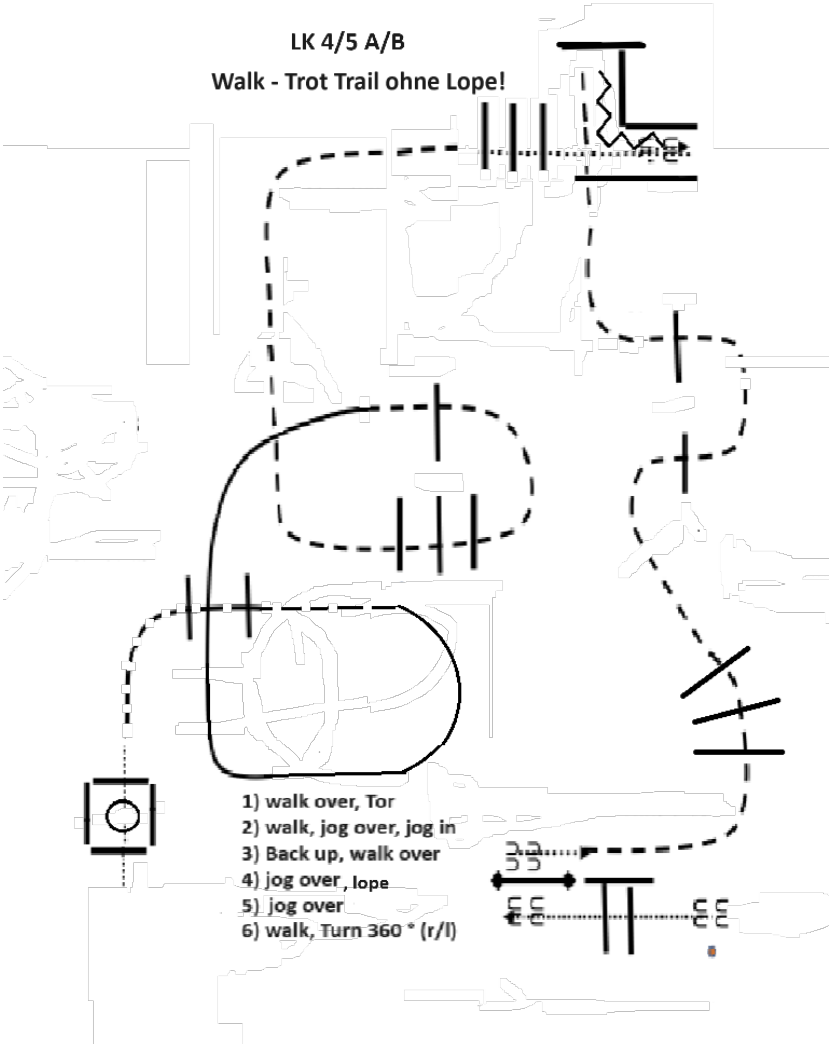

LK 1-3 A/B

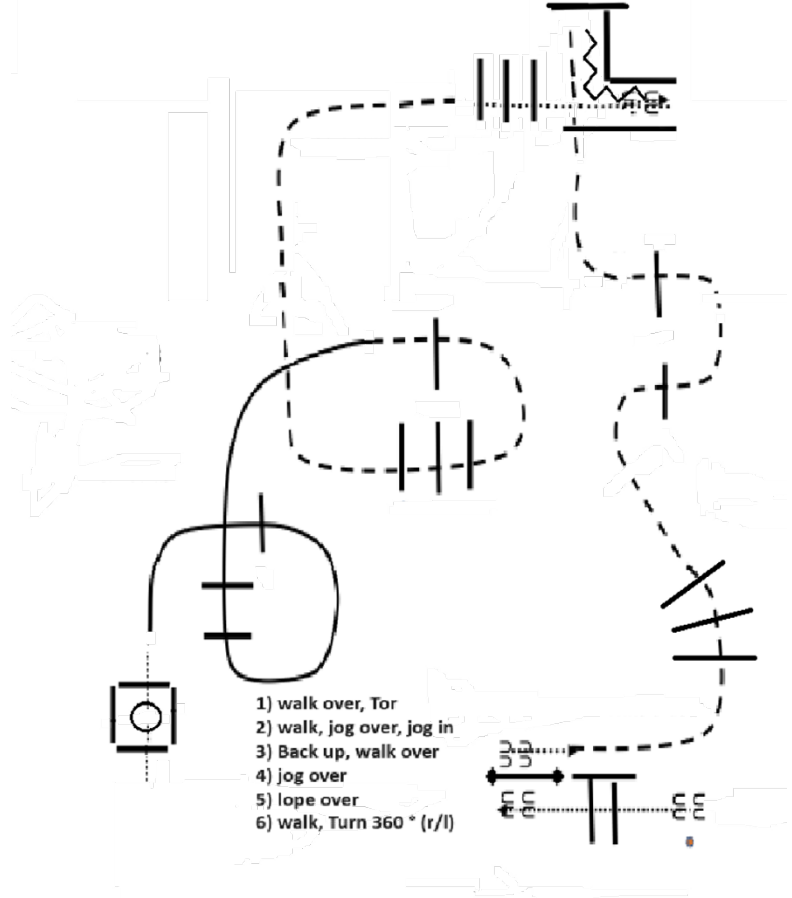

D Turnier – Samstag, 19.10.2024

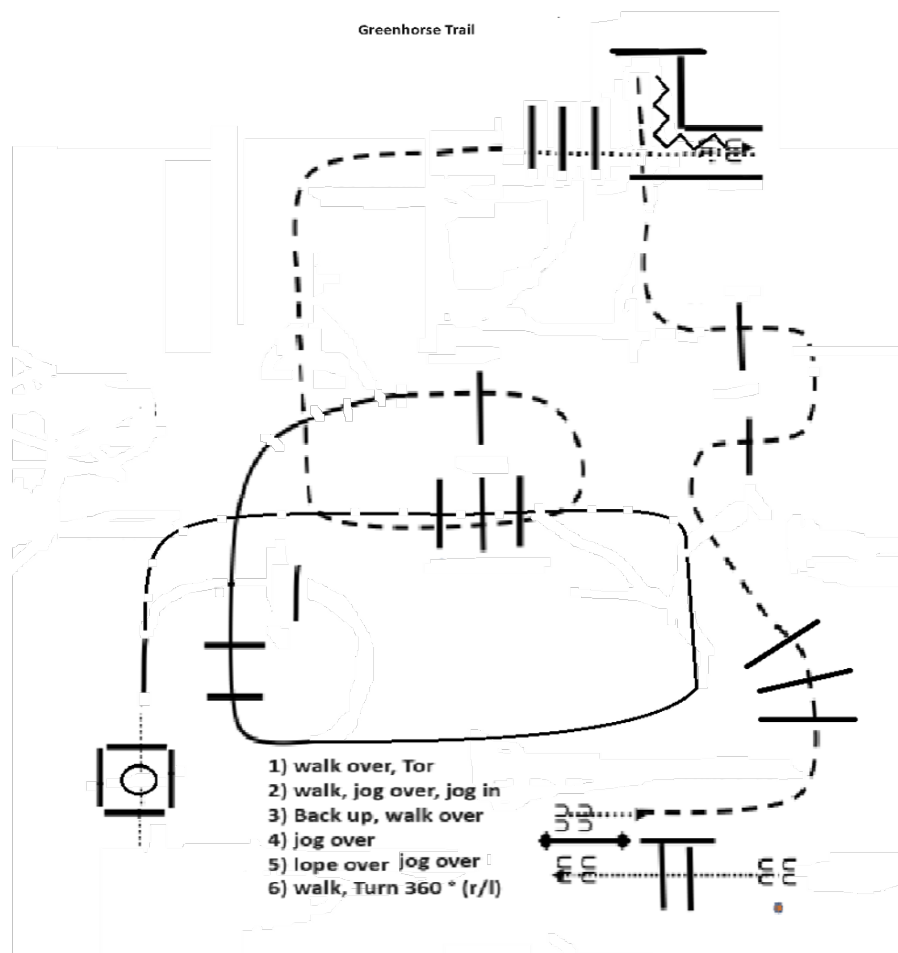

Anwaltskanzlei für Pferderecht

Rechtsberatung mit Pferdestärke:
[equiden-recht.de!](http://equiden-recht.de)

Kompetente Beratung insbesondere zu:

- Pferdekauf
- Pferdehaltung
- Pferdehalterhaftung
- Pferdedienstleister



Mehr Infos unter:
0 68 61 / 93 92 94 0
info@equiden-recht.de

Ein Produkt der
MK Rechtsanwalt

D Turnier – Samstag, 19.10.2024
 RR LK 4/5 A/B

#27 Ranch Riding LK 4/5 Arenagröße min. 20 x 40 Meter

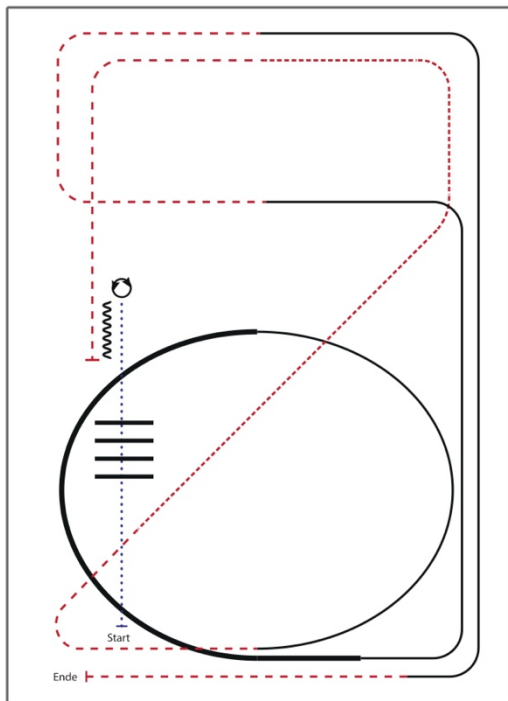

- 1) WALK
- 2) WALK OVER, WALK
- 3) STOP, TURN 360° (LEFT OR RIGHT)
- 4) BACK UP
- 5) TROT
- 6) EXTENDED TROT, TROT
- 7) LOPE LL
- 8) EXTENDED LOPE LL, LOPE LL
- 9) TROT
- 10) LOPE RL
- 11) TROT, STOP



RR LK 1-3A/B

#17 Ranch Riding Q jun. LK 1/2 LK 3 Arenagröße min. 20 x 40 Meter

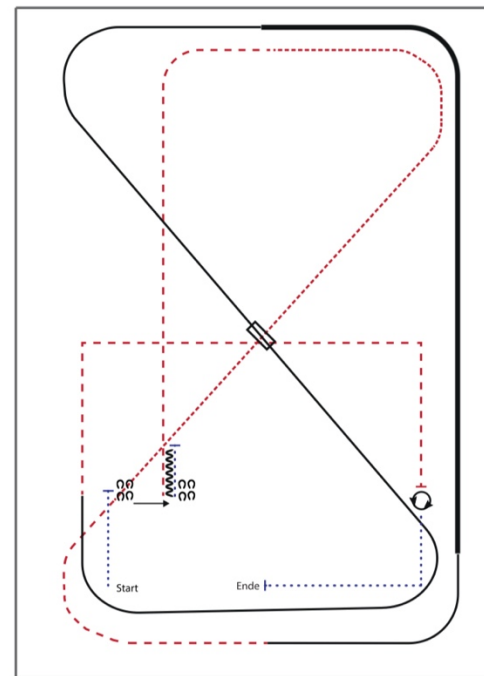

- 1) WALK, STOP
- 2) SIDEPASS RIGHT
- 3) WALK, STOP, BACK UP
- 4) TROT
- 5) EXTENDED TROT, TROT
- 6) LOPE LL
- 7) EXTENDED LOPE LL, LOPE LL
- 8) CHANGE LEADS (SIMPLE OR FLYING)
- 9) LOPE RL
- 10) TROT CORNERS
- 11) STOP, 360° TURN (LEFT OR RIGHT)
- 12) WALK, STOP



D Turnier – Samstag, 19.10.2024
Greenhorse Basis

Jungferde Basis Pattern 3 (4j.)

Start Ende

Legende:
 Schritt:
 Trab: - - - - -
 Galopp: ————
 Wechselzone: [Symbol]
 Rückwärts: [Symbol]

- Schritt durch die ganze Bahn, bei X Trab, Schlangenlinien durch die Bahn drei Bögen
- An der langen Seite Tritte verlängern (Leichttraben erlaubt)
- Mitte der kurzen Seite 2 Zirkel Linksgalopp, Mitte der kurzen Seite Trab
- Im Schritt durch die ganze Bahn wechseln, vor Erreichen des Hufschlags Trab
- Mitte der kurzen Seite 2 Zirkel Rechtsgalopp, Mitte der kurzen Seite Trab
- In Höhe des ersten Markers Schritt, Mitte der langen Seite abwenden, bei X Anhalten, HHW 540° (li. oder re.), eine Pferdelänge Rückwärtsrichten

Verharren, um das Ende der Prüfung anzuzeigen.

Jungferde

Greenhorse Ranch Riding

Jungferde Ranch Riding Pattern 7 (4j.)

Start Ende

Legende:
 Schritt:
 Trab: - - - - -
 Galopp: ————
 Wechselzone: [Symbol]
 Rückwärts: [Symbol]

- Walk, Trot
- Extended Trot, Trot
- Lope RL circle, Lope
- Trot, Walk, Stop, Turn 540° left or right
- Walk, Trot, Lope LL circle
- Trot, Stop, Back up

Jungferde

C Turnier Sonntag, 20.10.

SSH LK 1-3 A/B

#15 Showmanship at Halter Q LK 1/2 A/B

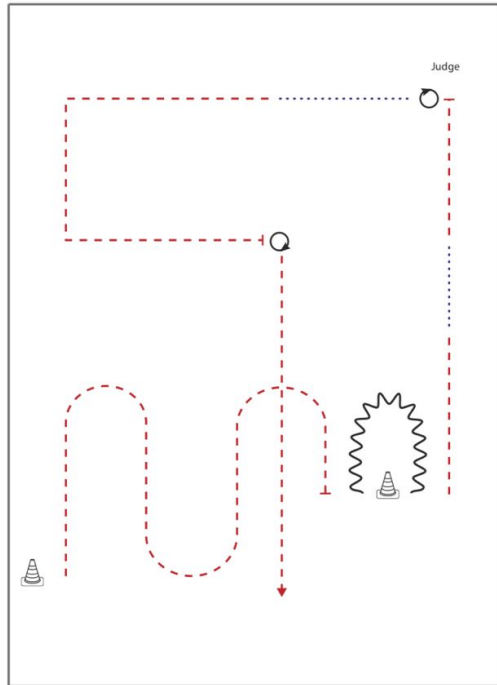

BE READY AT MARKER, SET UP

- 1) JOG, STOP
- 2) BACK UP
- 3) JOG, WALK
- 4) JOG, STOP
- 5) SET UP
- 6) INSPECTION
- 7) TURN 630°
- 8) WALK, JOG CORNERS
- 9) STOP, TURN 450°
- 10) JOG OUT

Walk (Schritt)
extended Walk
Trot/Jog (Trott)
Extended Trot
Lope (Galopp)
Extended Lope
Back Up (Rückwärtsrichten)	~~~~~
Lead Change (Galoppwechsel)	=====
Turn	○

LK 3 A WHS, 1-3 B WHS

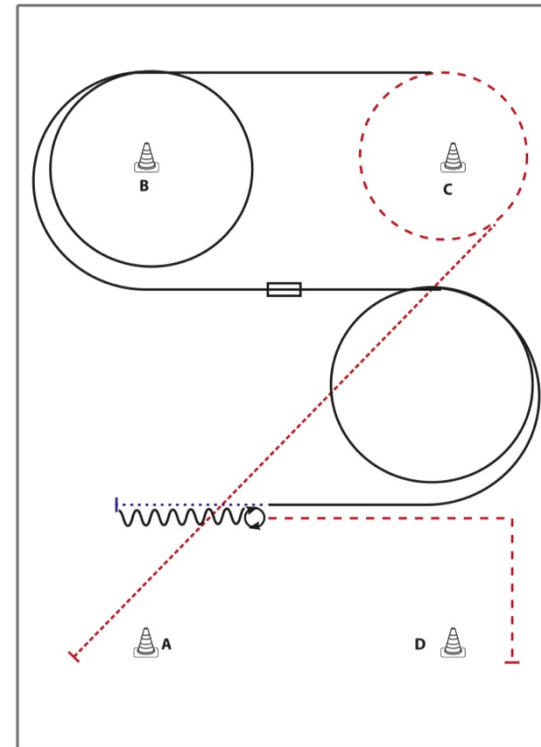

- 1) BE READY AT A, EXTENDED JOG
- 2) JOG
- 3) LOPE LL
- 4) CHANGE LEADS (SIMPLE OR FLYING)
- 5) LOPE RL
- 6) WALK
- 7) STOP, BACK UP (AT LEAST ONE HORSE LENGTH)
- 8) TURN 540° (LEFT OR RIGHT)
- 9) JOG, STOP
- WALK OUT

Walk (Schritt)
extended Walk
Trot/Jog (Trott)
Extended Trot
Lope (Galopp)
Extended Lope
Back Up (Rückwärtsrichten)	~~~~~
Lead Change (Galoppwechsel)	=====
Turn	○

C Turnier Sonntag, 20.10.
WHS LK 1/2A

#37 Western Horsemanship Q/M LK 1/2 A/B

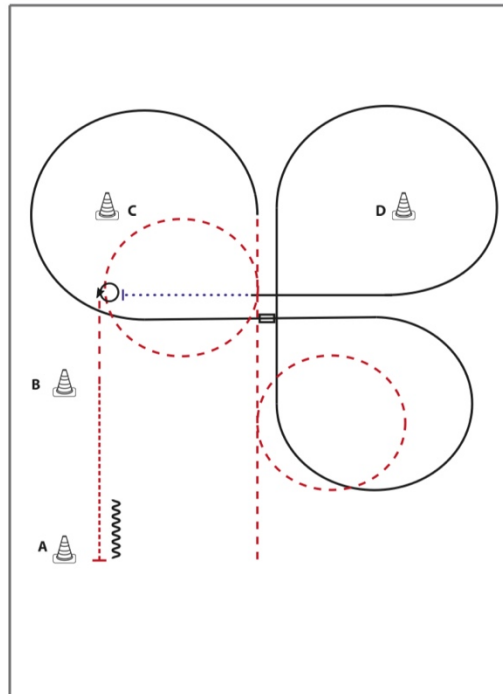

- 1) BE READY, JOG
 - 2) JOG SMALL CIRCLE RIGHT, JOG
 - 3) JOG SMALL CIRCLE LEFT
 - 4) LOPE LL
 - 5) CHANGE LEADS (SIMPLE OR FLYING)
 - 6) LOPE RL
 - 7) WALK
 - 8) STOP, TURN 450° LEFT
 - 9) JOG, EXTENDED JOG
 - 10) STOP, BACK UP (AT LEAST ONE HORSE LENGTH)
- WALK OUT

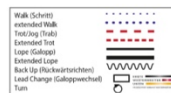

WT WHS ohne Lope! Strecke wird getrabt!

WHS 4/5 A+B

Erstellt V.S.

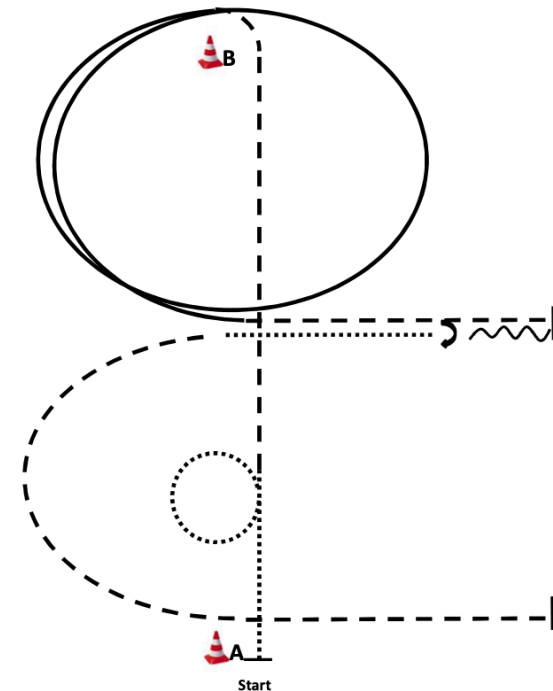

Start
 WARM UP AREA

1. Be ready at A, Walk, Walk very small circle.
2. Jog to B.
3. Lope left lead 1 1/2 circle.
4. Jog, stop.
5. Back one horse length.
6. 180° turn (opt. r/l).
7. Walk.
8. Jog, stop.

Walk to warm up area.

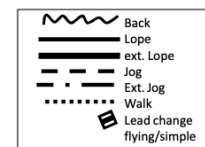

C Turnier Sonntag, 20.10.
LK 1-3 B RR, LK 3A RR

#25 Ranch Riding LK 1-3 Arenagröße min. 20 x 40 m

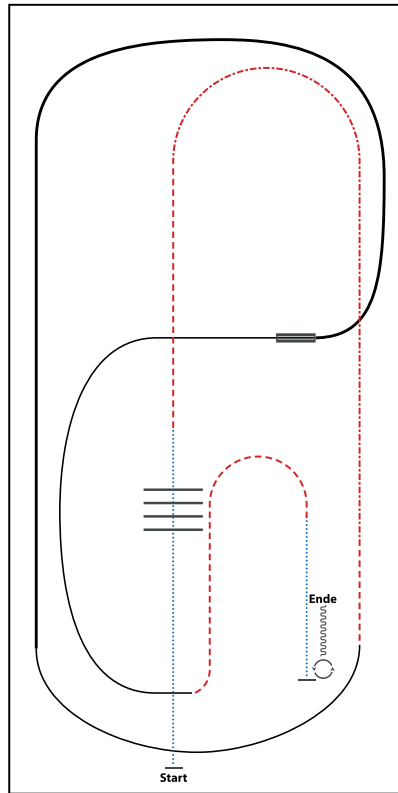

- 1) WALK OVER
- 2) TROT
- 3) EXTENDED TROT, TROT
- 4) LOPE (RL)
- 5) EXTENDED LOPE (RL)
- 6) CHANGE LEADS (SIMPLE OR FLYING)
- 7) LOPE (LL)
- 8) TROT
- 9) WALK
- 10) STOP, TURNS 360° (EACH DIRECTION)
- 11) BACK UP

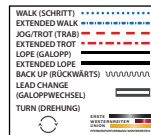

LK 1/2A RR

#19 Ranch Riding Q/M Jun. LK 1/2 + 3 Arenagröße min. 20 x 40 m

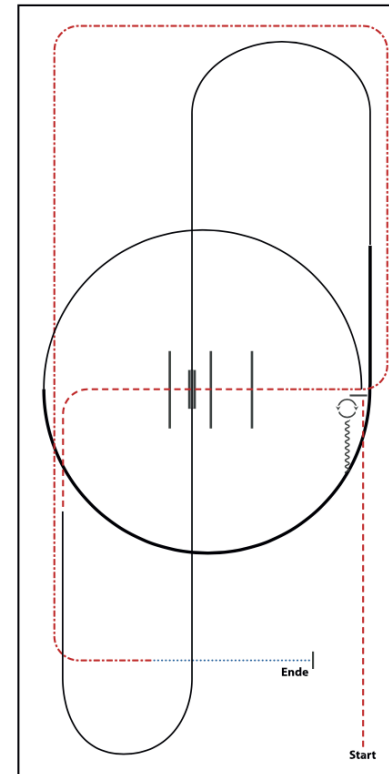

- 1) TROT
- 2) STOP, 180° TURNS EACH DIRECTION
- 3) BACK UP
- 4) LOPE (LL)
- 5) EXTENDED LOPE (LL), LOPE (LL)
- 6) CHANGE LEADS (SIMPLE OR FLYING)
- 7) LOPE (RL)
- 8) TROT, TROT OVER
- 9) EXTENDED TROT
- 10) WALK, STOP

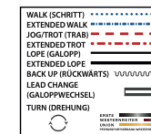

C Turnier Sonntag, 20.10. RR LK 4/5A/B

#32 Ranch Riding LK 4/5 Arenagröße min. 20 x 40 Meter

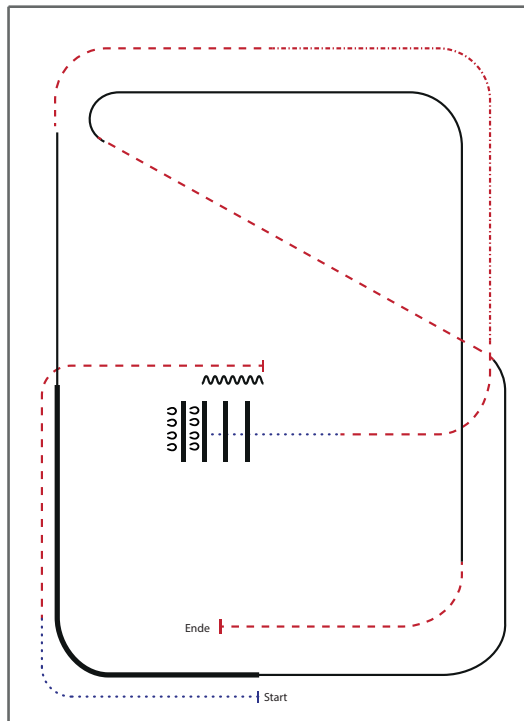

- 1) WALK
- 2) TROT
- 3) STOP, BACK UP
- 4) SIDEPASS RIGHT HALF WAY
- 5) WALK OVER
- 6) TROT
- 7) EXTENDED TROT, TROT
- 8) LOPE LL
- 9) EXTENDED LOPE LL
- 10) LOPE LL
- 11) TROT
- 12) LOPE RL
- 13) TROT, STOP

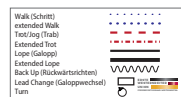

Pattern Walk-Trot Ranch Riding

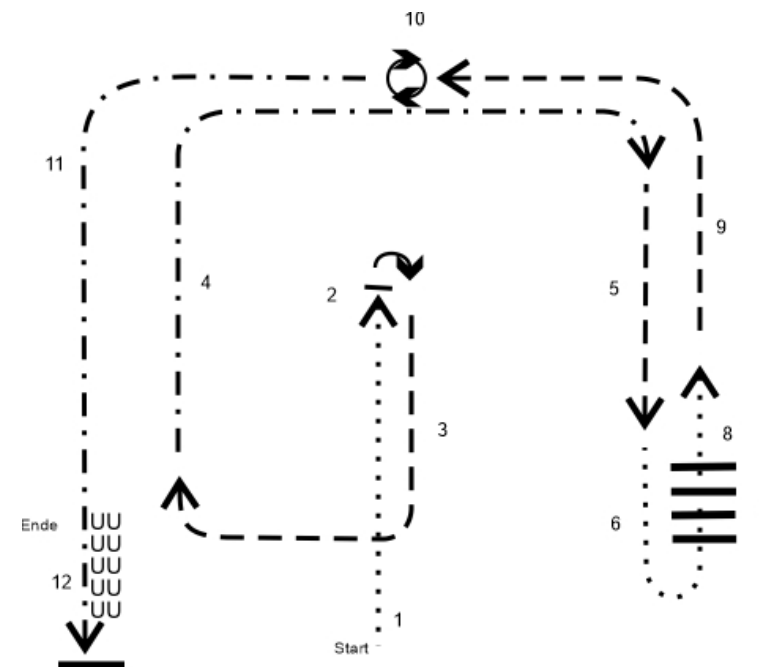

1. Schritt
2. Stop, 180° Hinterhandwendung rechts
3. Trab
4. verstärkter Trab
5. Trab
6. Schritt
7. Schritt über Stangen
8. Schritt
9. Trab
10. Stop, 360° Hinterhandwendung links
11. verstärkter Trab
12. Stop, Rückwärtsrichten

C Turnier, Sonntag, 20.10.

WT TH

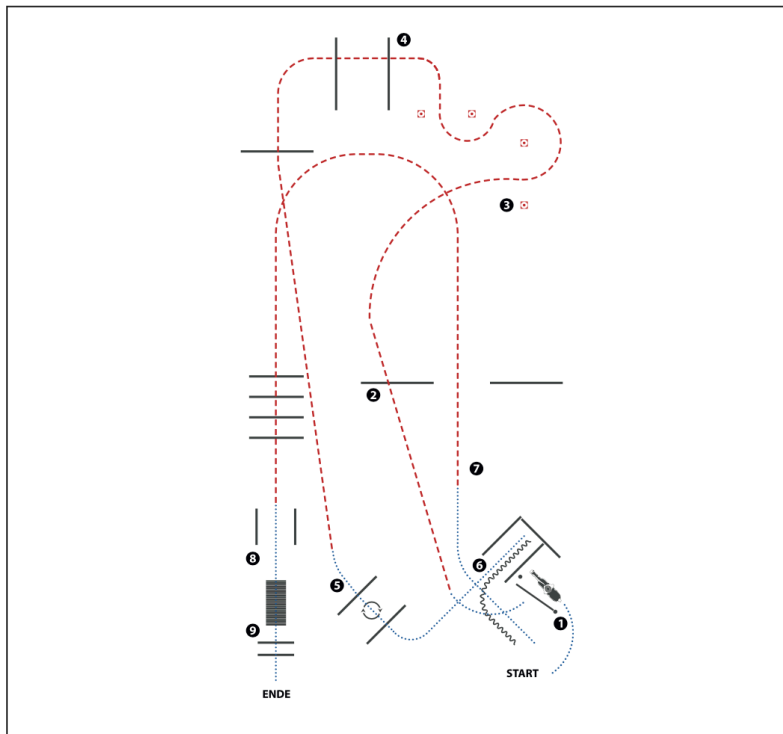

- 1) WALK, GATE, WALK (Schritt, Tor, schritt)
- 2) JOG OVER (Trabstangen)
- 3) JOG THRU MARKER (Trab durch Marker)
- 4) JOG OVER (Trabstangen)
- 5) WALK IN BOX, 360° TURN RIGHT, WALK OUT
(Im Schritt in die Box, 360° Wendung rechts, im Schritt aus der Box)
- 6) WALK INTO CHUTE, BACK UP
(Im Schritt in die Gasse, Rückwärts)
- 7) WALK, JOG OVER (Schritt, Trabstangen)
- 8) WALK OVER BRIDGE (Schritt über die Brücke)
- 9) WALK OVER (Schrittstangen)

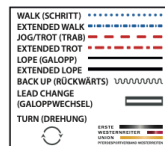

MEDIA PRODUCTION

C Turnier Sonntag, 20.10.
TH LK 1/2A

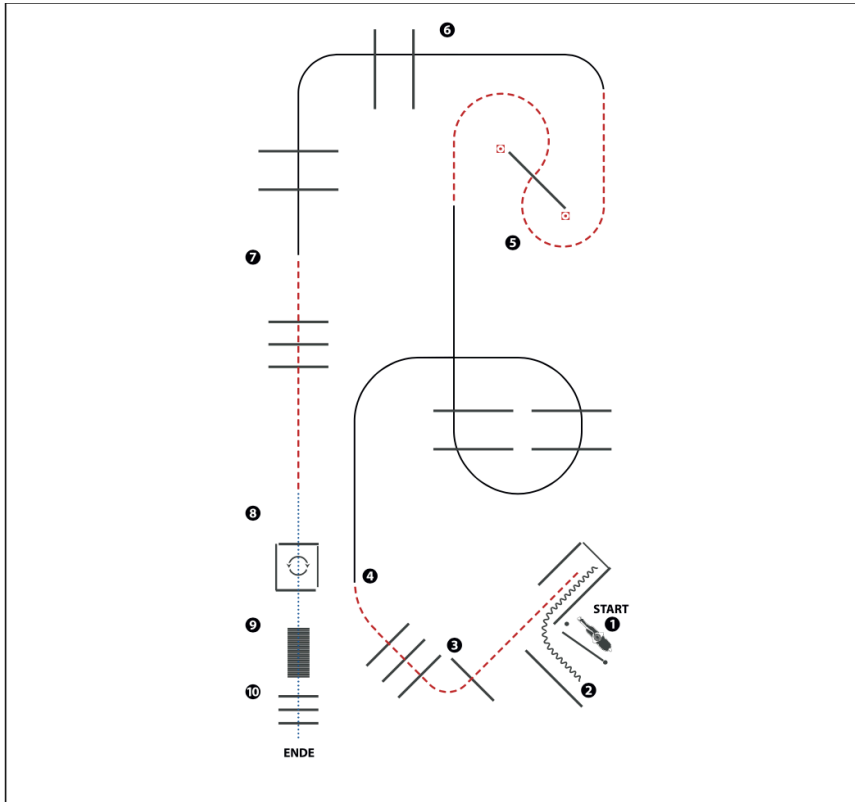

(Erhöhungen optional)

- 1) GATE LH
- 2) BACK UP, JOG OUT
- 3) JOG OVER
- 4) LOPE OVER (RL)
- 5) JOG OVER
- 6) LOPE OVER (LL)
- 7) JOG OVER
- 8) WALK INTO BOX, 360° TURN EITHER WAY, WALK OUT
- 9) BRIDGE
- 10) WALK OVER

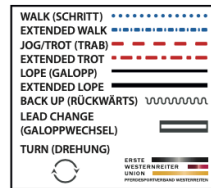

TH LK 3 A / LK 1-3 B

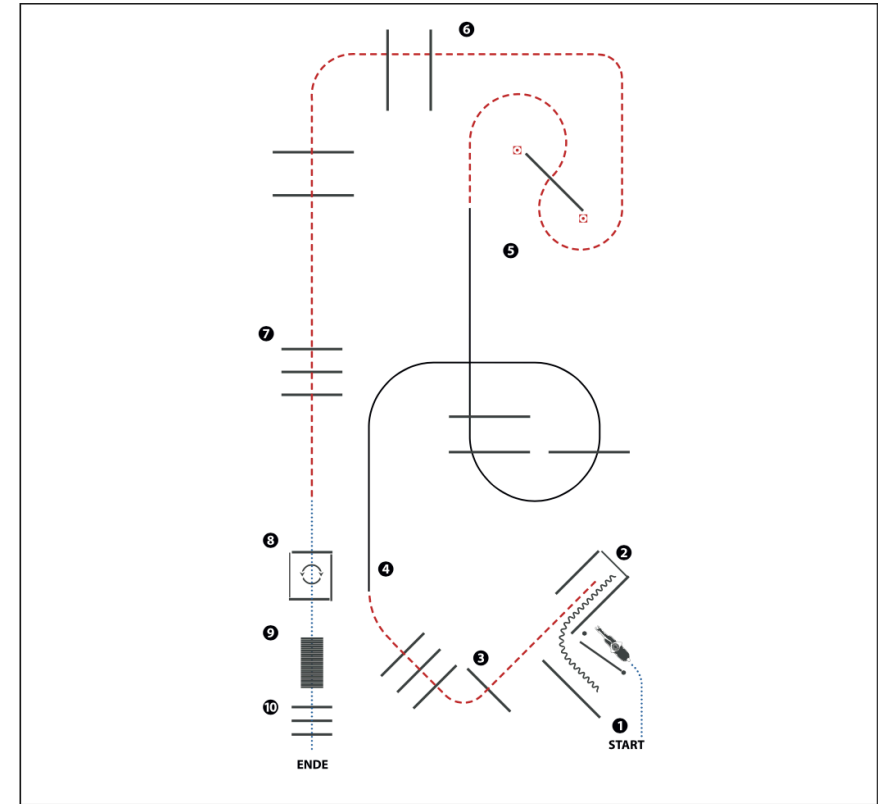

(Erhöhungen optional)

- 1) GATE LH
- 2) BACK UP, JOG OUT
- 3) JOG OVER
- 4) LOPE OVER (RL)
- 5) JOG OVER
- 6) JOG OVER
- 7) JOG OVER
- 8) WALK INTO BOX, 360° TURN EITHER WAY, WALK OUT
- 9) BRIDGE
- 10) WALK OVER

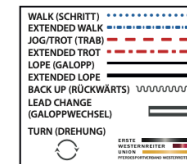

C Turnier Sonntag, 20.10.
LK4/5 A/B

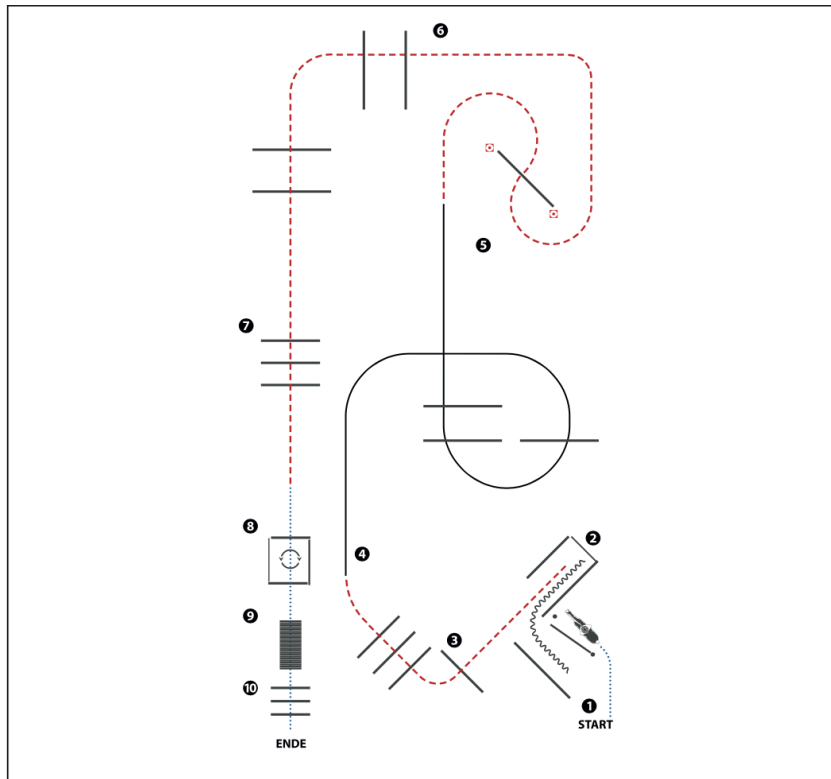

(Erhöhungen optional)

- 1) GATE LH
- 2) BACK UP, JOG OUT
- 3) JOG OVER
- 4) LOPE OVER (RL)
- 5) JOG OVER
- 6) JOG OVER
- 7) JOG OVER
- 8) WALK INTO BOX, 360° TURN EITHER WAY, WALK OUT
- 9) BRIDGE
- 10) WALK OVER

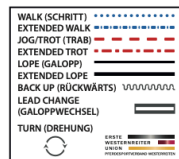

TIERVERSICHERUNG MIT ERFAHRUNG UND HERZ

Für dich und dein Pferd.

40
Jahre

Tierkranken-
versicherung

uelzener.de/pferd

Die Pferdeversicherungen der Uelzener.
Ermögliche deinem Pferd die beste gesundheitliche Versorgung – auch bei steigenden Tierarztkosten.

Ruf uns unverbindlich an.
Tel. 0581 8070-4646

