

Patternnliste:

Western Riding

LK 3A Pattern 5

LK 1/2 A/B Pattern 1

Reining

LK 4 A Pattern 8

LK 4B Pattern 8A

LK 3B Pattern 8A

LK 3A Pattern 4

R 841 Rasseoffen Pattern 10

O 342 Sen. RN Open Pattern 10

LK 1/2 A/B Pattern 2

N370 Non Pro Pattern 8

O 341 jun. Open Pattern 5

R840 Rasseoffen a. A. Pattern 1

Superhorse LK 1/2 A/B Pattern 3

Appaloosa Round Up 2013
EWU-C-Trophy-Turnier

Showmanship at Halter
LK 4/5A und LK 3/4B EWU

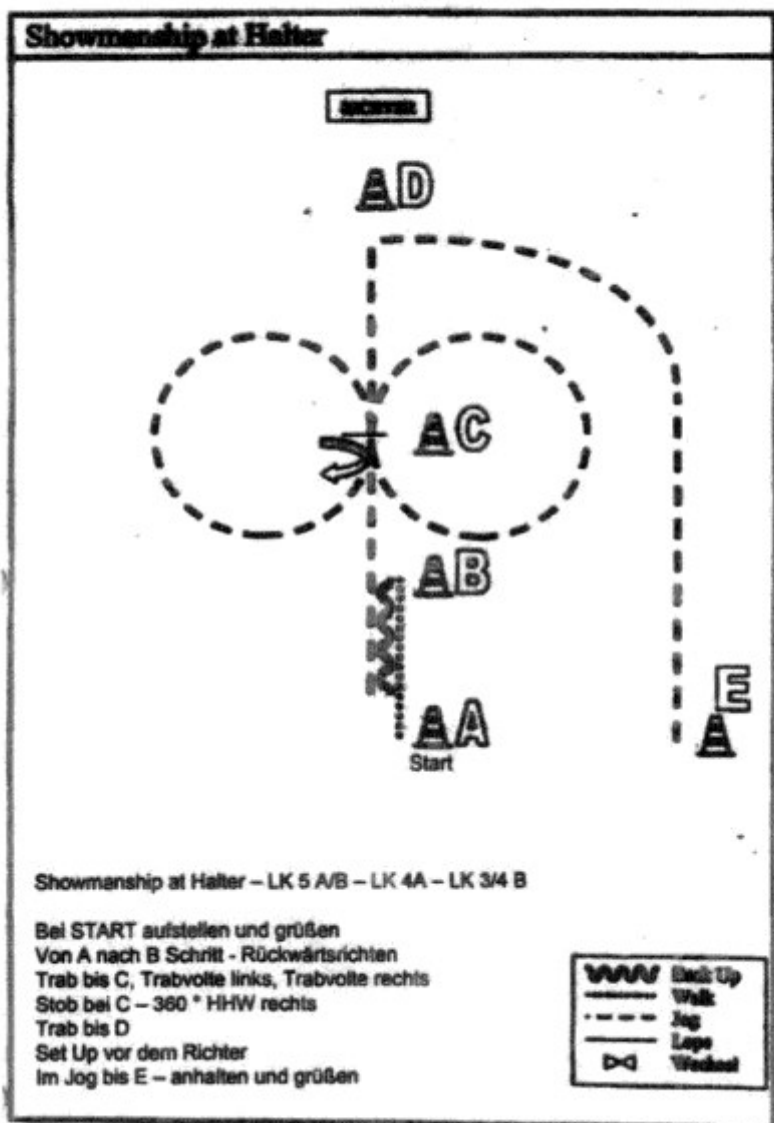

Appaloosa Round Up 2013
EWU-C-Trophy-Turnier

Showmanship at Halter – Y110

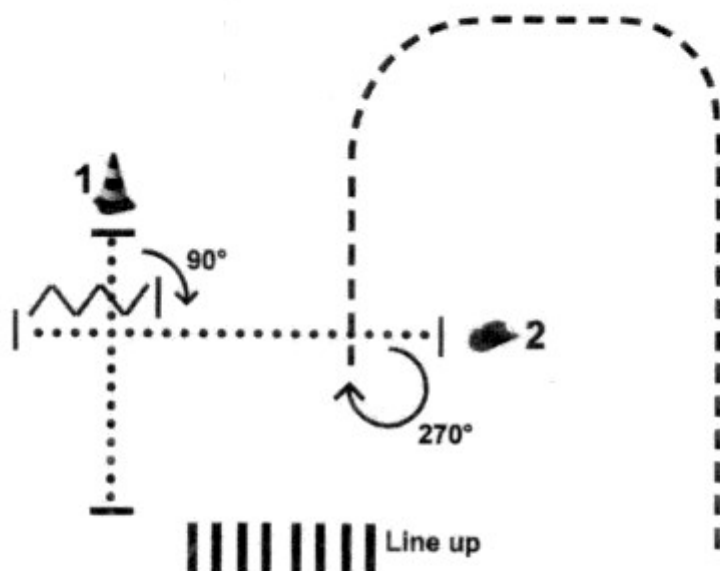



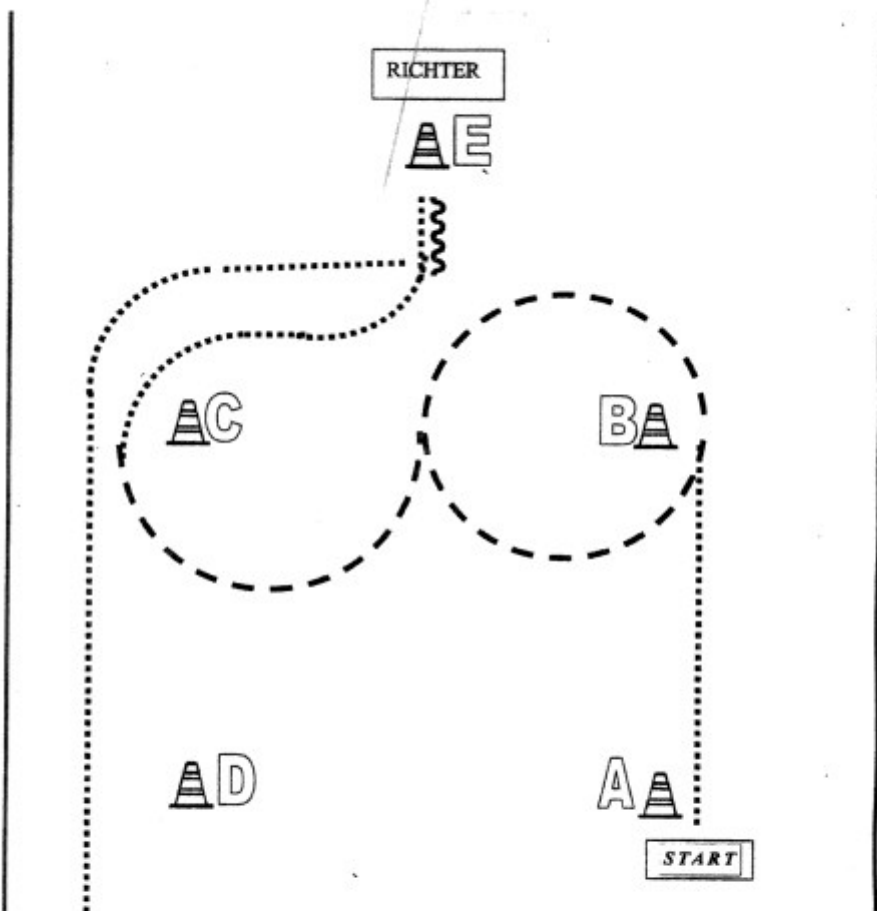

1. Im Schritt zu 1.
3. Stop vor 1.
2. 90° Hinterhandwendung nach rechts.
4. 6 Tritte rückwärts richten.
5. Im Schritt zum Richter (2).
6. Aufstellen zur Begutachtung durch den Richter.
7. 270° Hinterhandwendung nach rechts.
8. Im Jog zum Linen up.

Appaloosa Round Up 2013
 EWU-C-Trophy-Turnier
 Showmanship at Halter N 310



Von A bis B im Walk
 Bei B Jog und 1 1/2 Volte um B
 1/2 Volte rechts zu C
 Bei C Walk und weiter zu E
 Bei E Set Up vor dem Richter
 Nach dem Set Up mind. 1 Pferdelänge rückwärts richten
 Im Walk zurück ins Line Up

	Back Up
	Walk
	Jog
	Lope
	Wechsel

Appaloosa Round Up 2013
EWU-C-Trophy-Turnier

LK 5A und LK 4/5B EWU
Western Horsemanship

www.HorseShowPatterns.com

www.HorseShowPatterns.com

1. Walk to A.
2. At A stop and back 3 steps.
3. Jog A to B.
4. Stop at B and perform a 360 degree turn to the right.
5. Jog a circle to the right around C.
6. At B lope on the left lead, lope a circle to the left around D.
7. Continue the lope to E.
8. Stop at E.

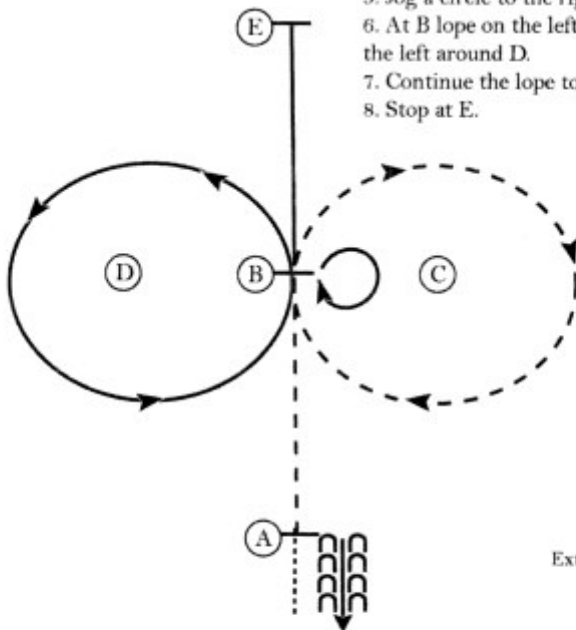

Walk
Jog	- - - - -
Extended Jog	—————
Lope	—————
Leg Yield	
Lead Change	↘ ↙
Back	← ← ← ← ←
Marker	⊙ (B)
Sidepass	→ - - - - -

Pattern Provided by:

[WHI_1]

Appaloosa Round Up 2013
EWU-C-Trophy-Turnier

Western Horsemanship
LK 4A EWU

www.HorseShowPatterns.com

www.HorseShowPatterns.com

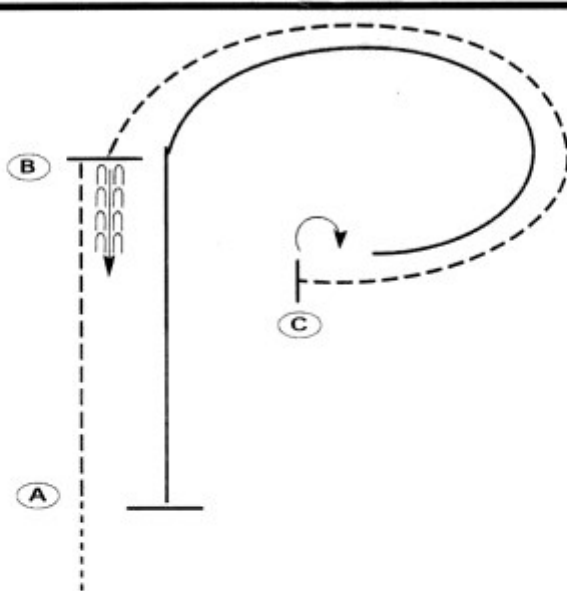

Be ready before A.

1. Walk to A.
2. Jog to B.
3. Stop at B and back approximately one horse length.
4. Jog to C.
5. Stop at C and turn 180 degrees to the right.
6. Lope on the left lead past B and to A.
7. Stop at A.

Follow the instructions of your ring steward.

Walk	-----
Jog	- - - - -
Extended Jog	— — — — —
Lope	— — — — —
Leg Yield	
Lead Change	— / —
Back	← 3333
Marker	(B)
Sidepass	← — — — — →

[WHI_4]

Pattern Provided by:
Petra Retthofer

Appaloosa Round Up 2013
EWU-C-Trophy-Turnier

Western Horsemanship
LK 3 EWU

www.HorseShowPatterns.com

www.HorseShowPatterns.com

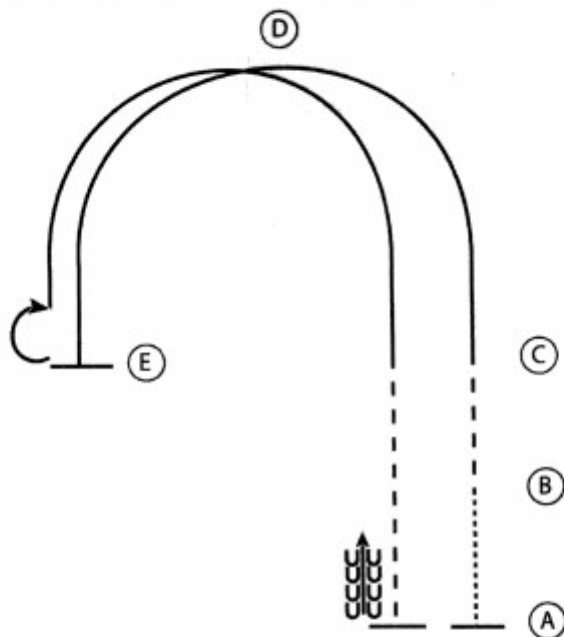

1. Walk A to B
2. At B jog to C
3. At C lope on the left lead in a half circle to E
4. Stop at E and perform a 180 degree turn to the right
5. Lope on the right lead in a half circle to C
6. At C jog to A
7. At A stop and back 4 steps

Walk
Jog	-----
Extended Jog	- - - - -
Lope	—————
Leg Yield	
Lead Change	↗ ↘
Back	↖ ↙
Marker	(B)
Sidepass	← - - - - →

Pattern Provided by:
Petra Retthofer

[WHII_2]

Appaloosa Round Up 2013
EWU-C-Trophy-Turnier

Western Horsemanship
LK 1/2 EWU

www.HorseShowPatterns.com

www.HorseShowPatterns.com

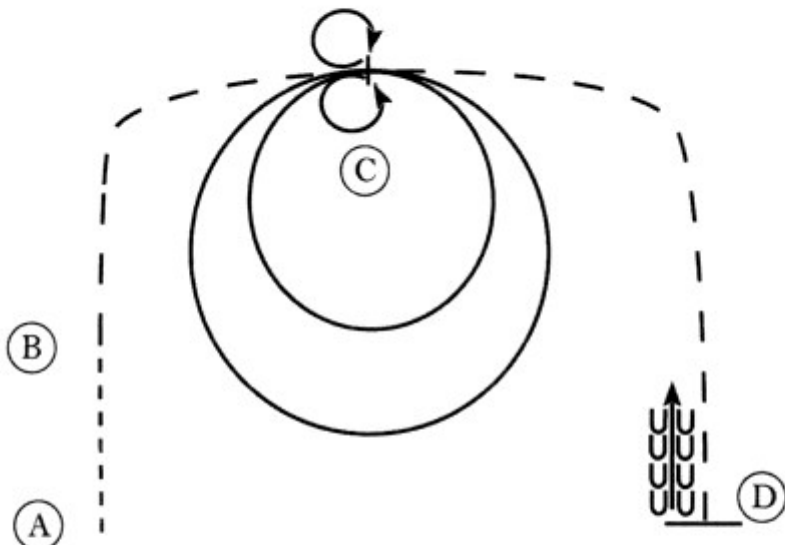

1. Jog A to B
2. At B extend the jog to C
3. Stop at C and perform a 360 degree turn to the left
4. Lope a small, slow circle around C on the left lead
5. Stop at C and perform a 360 degree turn to the right
6. Lope a circle with speed around C on the right lead
7. At C extend the jog to D
8. Stop at D and back approximately one horse length.

Walk	-----
Jog	- - - - -
Extended Jog	-----
Lope	—————
Leg Yield	
Lead Change	↗ ↘
Back	←←←←←
Marker	⊙ (B)
Sidepass	←-----→

[WHIII_1]

Pattern Provided by:
Petra Retthofer

Appaloosa Round Up 2013 - C-Trophy EWU

Hunt Seat Equitation (N320 Non Pro Western Equitation)

Show Date: 19.-21.07.2013

www.HorseShowPatterns.com

www.HorseShowPatterns.com

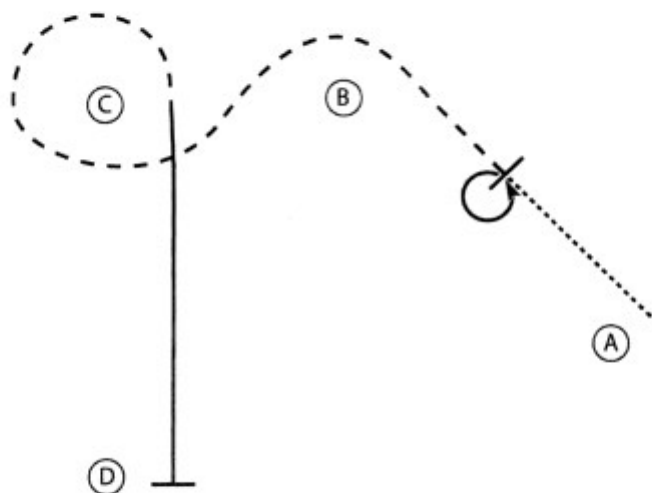

1. At A walk halfway to B
2. Stop and perform a 360 degree turn to the left on the hindquarters
3. Posting trot to and around B and in a circle around C, performing proper change of diagonal
4. At C canter to D on the right lead
5. Stop at D

- Walk|
- Trot - - - - -|
- Extended T rot ————|
- Canter ————|
- Leg Yield |||||
- Lead Change
- Back
- Marker
- Sidepass

[HSEII_1]

Pattern Provided by:
Petra Retthofer

Appaloosa Round Up 2013 - C-Trophy
EWU
Hunt Seat Equitation (Y140 Western Equitation Youth)

Show Date: 19.-21.07.2013

www.HorseShowPatterns.com

www.HorseShowPatterns.com

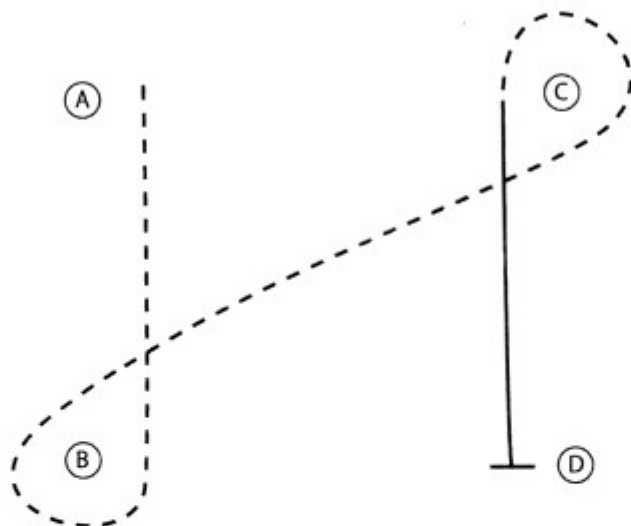

1. Sitting trot to and around B
2. Posting trot to and around C on the right diagonal
3. At C canter to D on the right lead
4. Stop at D

Walk
Trot	- - - - -
Extended Trot	- - - - -
Canter	—————
Leg Yield	
Lead Change	↗ ↘
Back	← ← ← ← ←
Marker	⊙
Sidepass	↔

[HSEII_3]

Pattern Provided by:
Petra Retthofer

Appaloosa Round Up 2013 - C-Trophy

EWU

Hunt Seat Equitation (Western Equitation Rasseoffen)

Show Date: 19.-21.07.2013

www.HorseShowPatterns.com

www.HorseShowPatterns.com

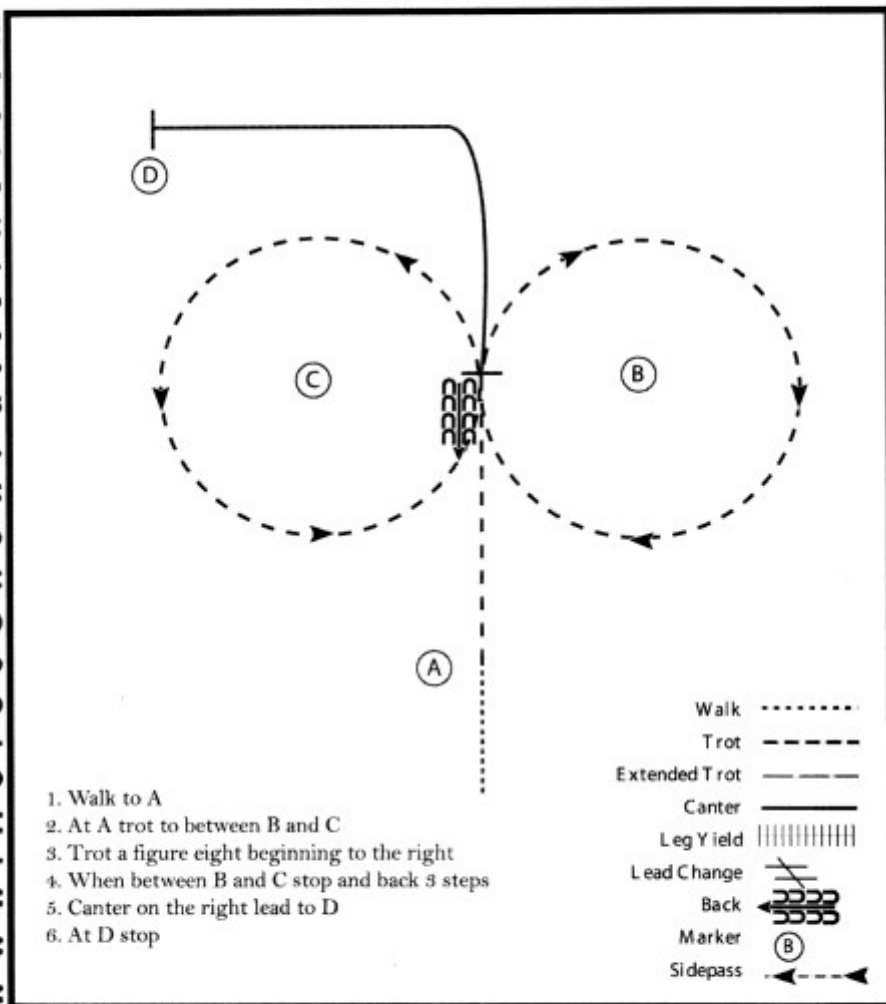

1. Walk to A
2. At A trot to between B and C
3. Trot a figure eight beginning to the right
4. When between B and C stop and back 3 steps
5. Canter on the right lead to D
6. At D stop

- Walk|
- Trot - - - - -|
- Extended Trot - - - - -|
- Canter _____|
- Leg Yield |||||
- Lead Change / / / / /
- Back ← ← ← ← ←
- Marker (B)
- Sidepass - - - - -|

[HSEI_4]

Pattern Provided by:
Petra Retthofer

Appaloosa Round Up 2013 - C-Trophy EWU

Hunt Seat Equitation (Walk Trot Western Equitation Rasseoffen)

Show Date: 19.-21.07.2013

w w w . H o r s e S h o w P a t t e r n s . c o m

w w w . H o r s e S h o w P a t t e r n s . c o m

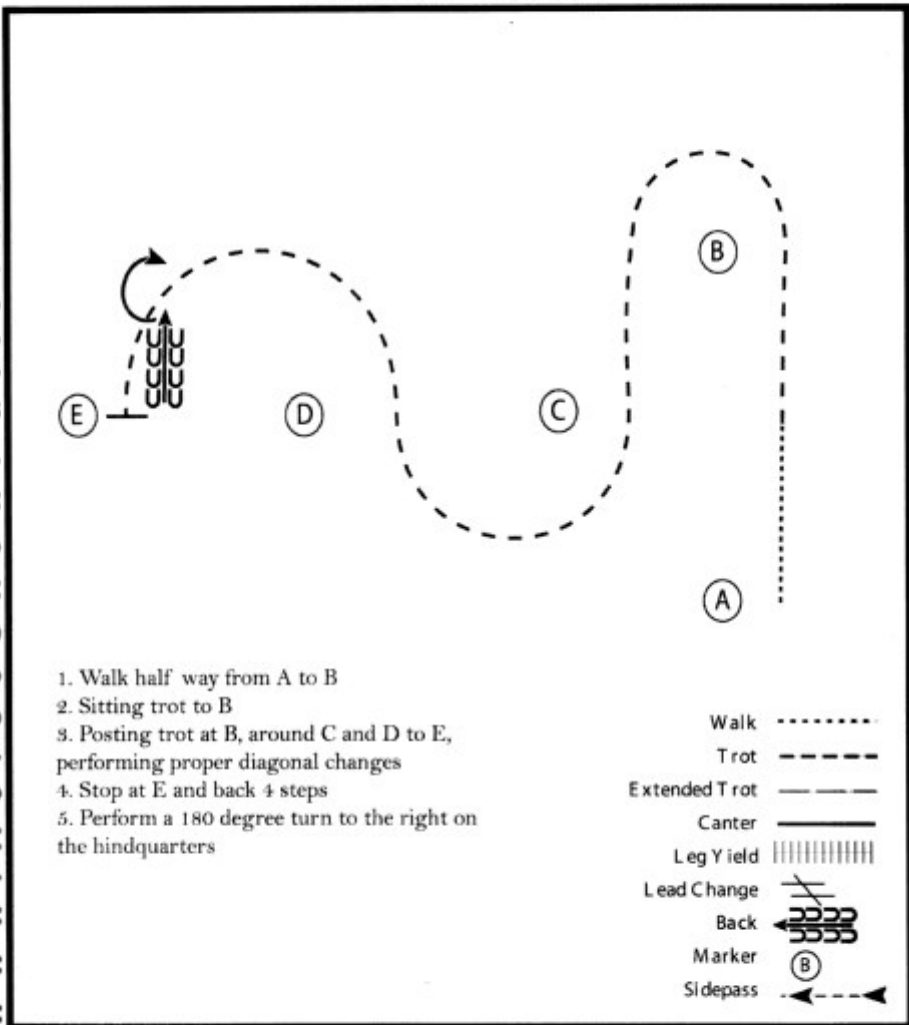

1. Walk half way from A to B
2. Sitting trot to B
3. Posting trot at B, around C and D to E, performing proper diagonal changes
4. Stop at E and back 4 steps
5. Perform a 180 degree turn to the right on the hindquarters

- Walk|
- Trot - - - - -|
- Extended Trot - - - - -|
- Canter _____|
- Leg Yield |||||
- Lead Change / / / / /
- Back ←←←←←
- Marker (B)
- Sidepass ← - - - - - →

[HSE WT_3]



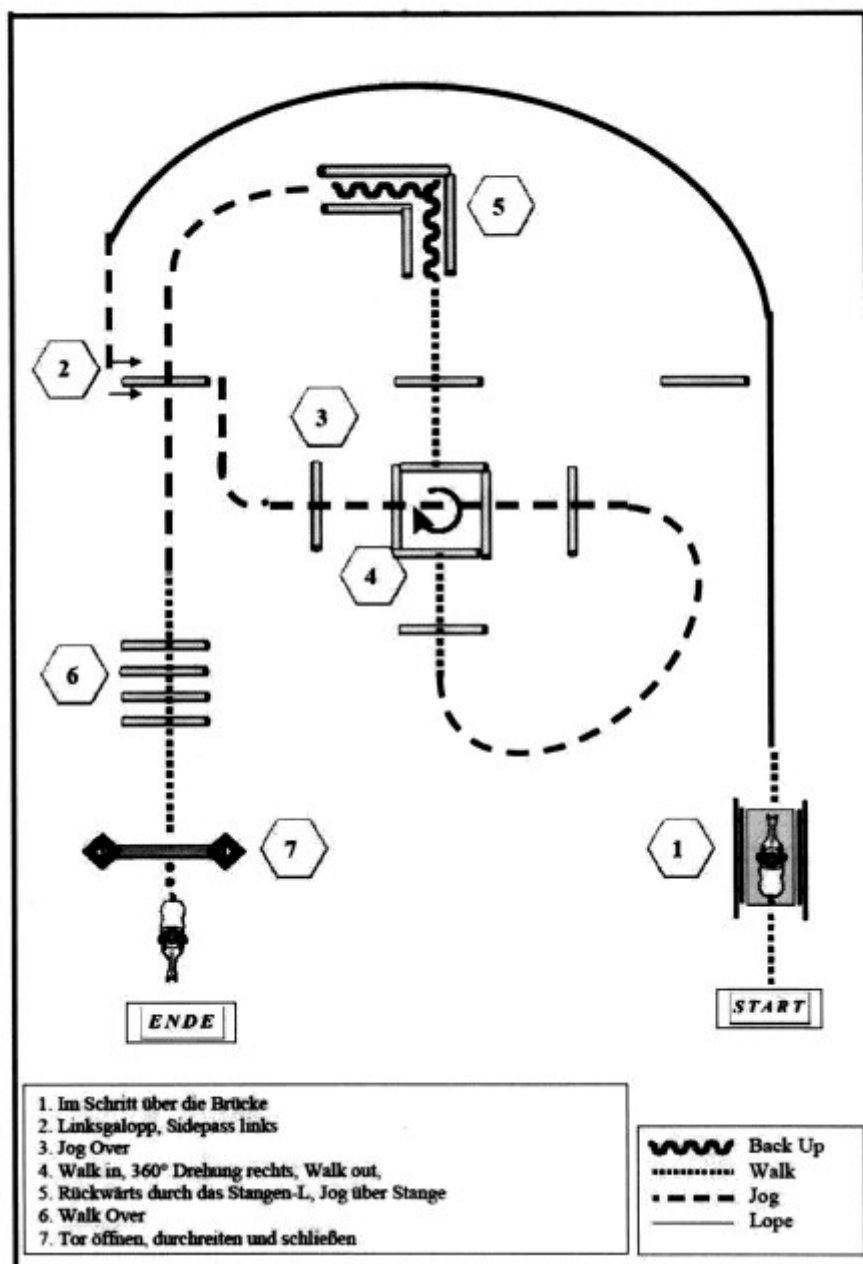

Pattern Provided by:
Petra Retthofer

Appaloosa Round Up 2013
EWU-C-Trophy-Turnier

LK 4A Trail EWU



1. Im Schritt über die Brücke
2. Linksgalopp, Sidepass links
3. Jog Over
4. Walk in, 360° Drehung rechts, Walk out,
5. Rückwärts durch das Stangen-L, Jog über Stange
6. Walk Over
7. Tor öffnen, durchreiten und schließen



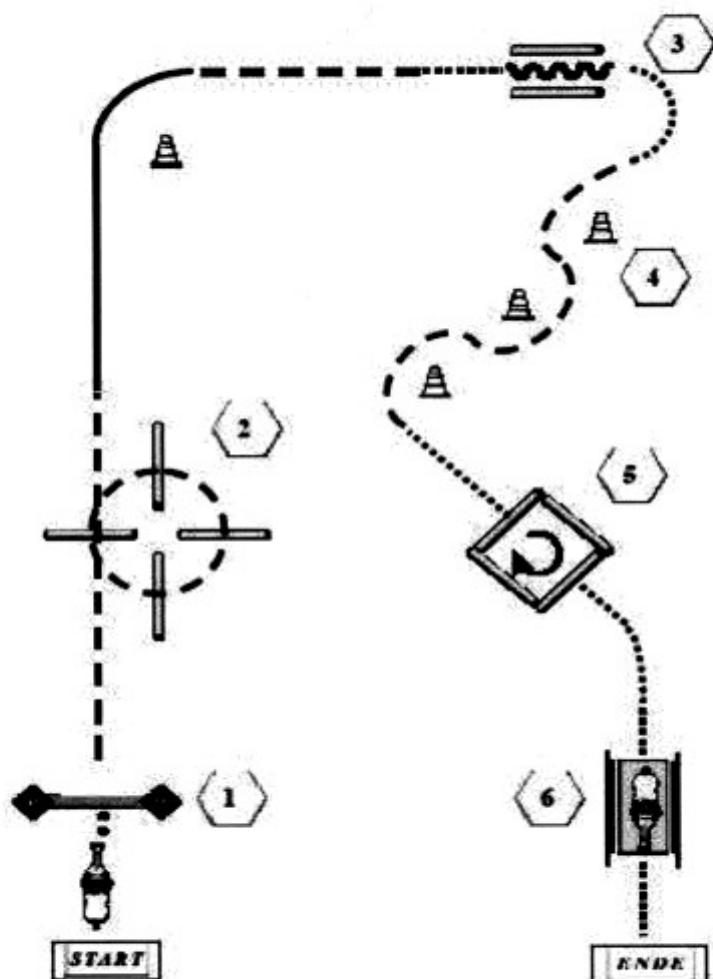

-  Back Up
 Walk
 Jog
 Lope

Appaloosa Round Up 2013
EWU-C-Trophy-Turnier

LK 5A und LK 4/5B Trail EWU



1. Tor öffnen, durchreiten und schließen.
2. Trab über die Stangen.
3. Rückwärts durch die Stangen.
4. Trab-Slalom
5. Schritt in die Box, 360° Drehung rechts, im Schritt raus.
6. Im Schritt über die Brücke.

-  Back Up
 Walk
 Jog
 Lope

Appaloosa Round Up 2013
EWU-C-Trophy-Turnier

LK 1/2 Trail EWU
Open sen. Trail

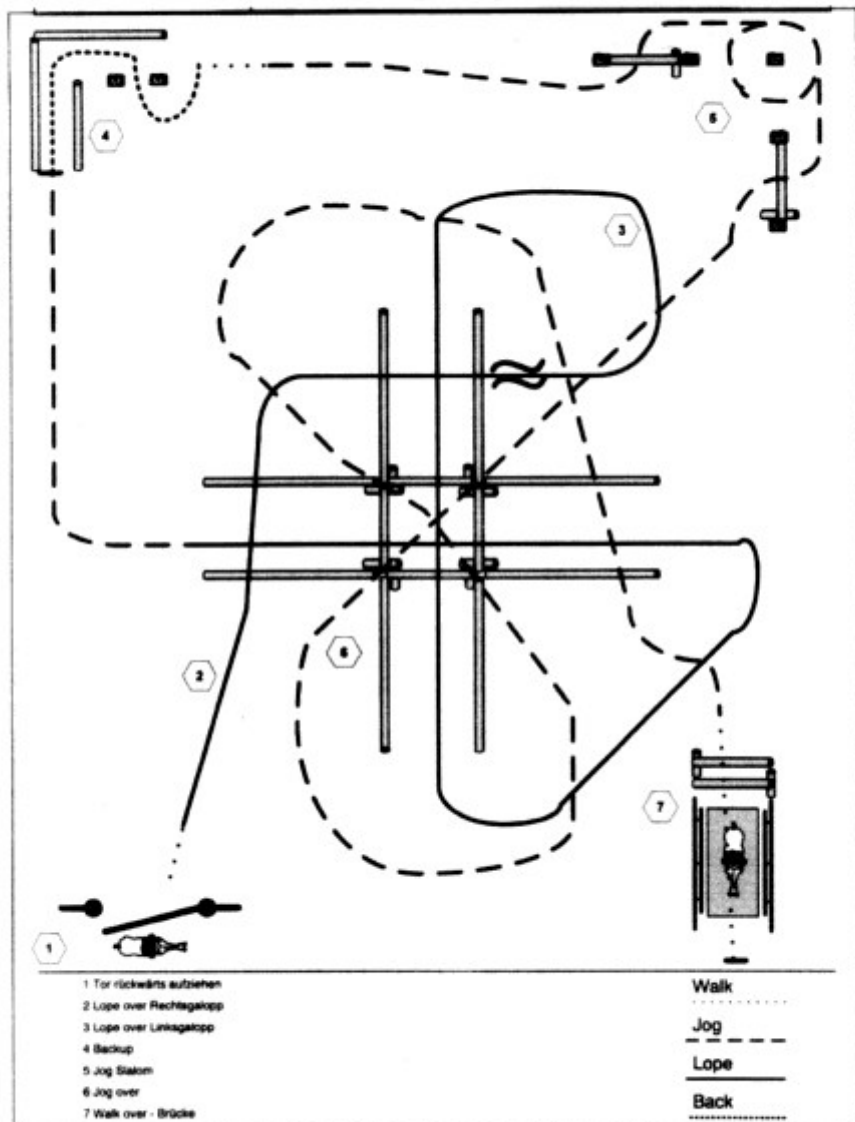

Appaloosa Round Up 2013
EWU-C-Trophy-Turnier

Jackpot Trail

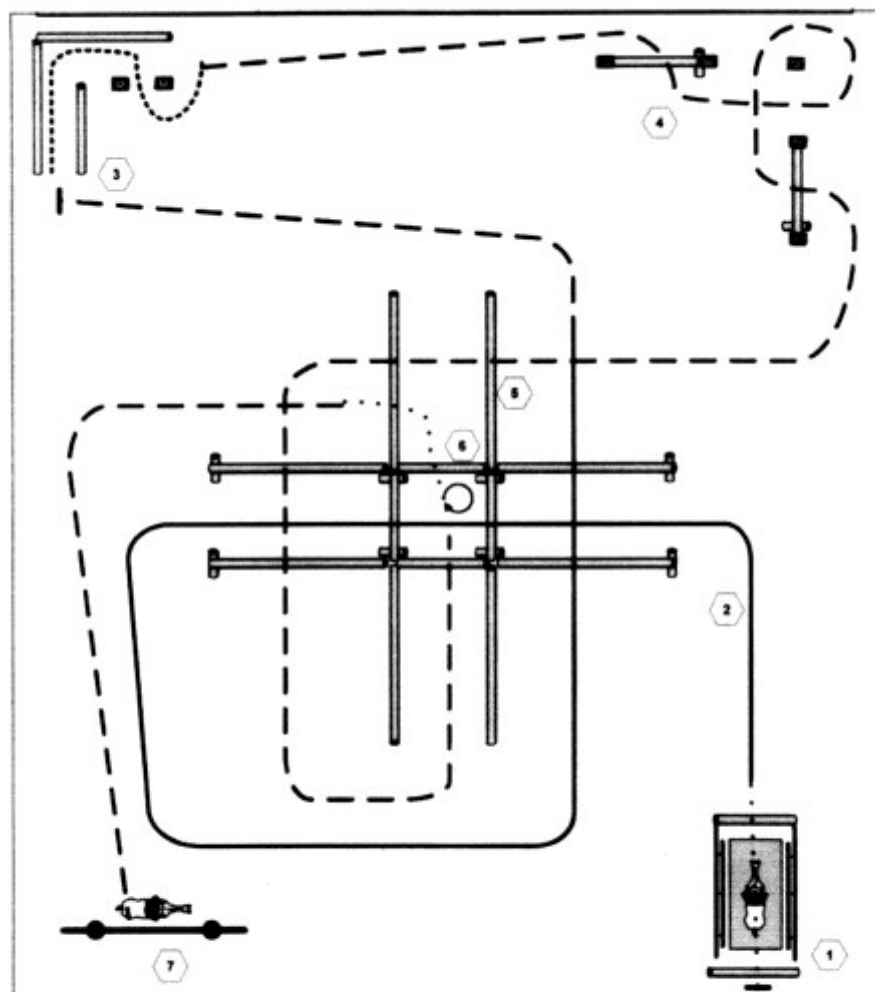

- 1 Walk over - Brücke - Walk over
- 2 Lope over Linkagelopp
- 3 Backup
- 4 Jog Stallion
- 5 Jog over
- 6 Jog in, 360° rechts - Walk out - over
- 7 Tor rückwärts

- Walk
.....
Jog
.....
Lope

Back
- . - .

Appaloosa Round Up 2013
EWU-C-Trophy-Turnier

Trail Youth und Trail Rasseoffen

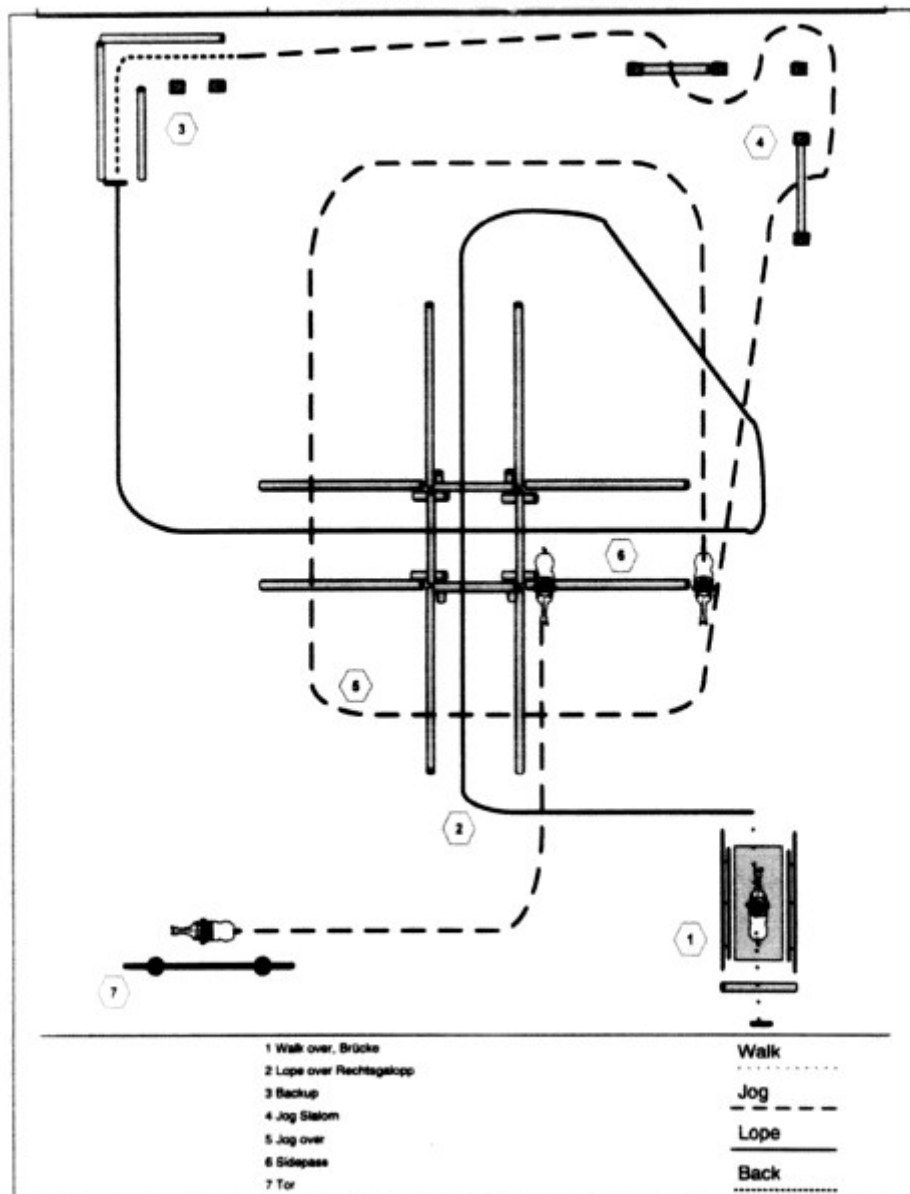

Appaloosa Round Up 2013
EWU-C-Trophy-Turnier

LK 3A EWU / Non Pro / jun. Open Trail

